



SURFACE MOUNT NOMENCLATURE AND PACKAGING

Tel 800-776-9888 Email info@topline.tv

w w w . t o p l i n e . t v

Contents

Overview	3
Flat Chip	4
MELF Components	10
Tantalum Capacitors	12
Transistors and Diodes	14
Lead Styles	20
SOIC	22
TSOP	27
PLCC	28
LCC	29
Flat Packs	30
QFP	31
BGA (Ball Grid Array)	36
Flip Chips	37
Micro BGA	38
Fine Pitch Terminology	39
TopArt	42

OVERVIEW

This booklet is a plain-English introduction to surface mount nomenclature and packaging. Soon you will be speaking the language of Surface Mount just like a professional.

1. Nomenclature

There are many different types of surface mount packages. Each time a new surface mount package is developed a new name is created. These names are usually abbreviated by their initials. As an example: The Quad Flat Pack is commonly known as the QFP. Unfortunately, some packages have more than one name. This sometimes creates confusion in the industry. I will do my best to explain the subtle differences between component types.

2. Package versus Packaging

Let's start by clarifying the difference between the words "package(s)" and "packaging." The word "package" is used in this book to refer to the component's physical shape or outline. The word "packaging" is used in this book to describe how the component is stored. As an example: Tape and Reel is the packaging. QFP is a package.

3. Trends

Surface mount technology changes rapidly. However, trends can be identified. This book includes my observations of industry trends. By understanding these trends, you will gain a fuller appreciation of the components described in this book. They will begin to take on a life of their own and will become more meaningful to you than just names on a page.

FLAT CHIP NOMENCLATURE

Let's start out by studying simple flat chip components such as ceramic capacitors and resistors.

The footprint (size) of flat chips is identified by a 4-digit size code.

In the USA, this 4-digit size code is measured in inches. Outside the USA, the size code may be either millimeters or inches. This can cause confusion, so it is important to verify whether the size code is in metric or inches.

The first two digits in the size code refer to the length (L) from Termination-to-Termination. The second two digits refer to the width (W) of the termination.

For example, if the first two digits in the size code are **12**, then the length of the flat chip is **.12"**. However, if the size code is metric, the **12** would equal **1.2mm**.

The thickness (T) of the package is not included in the 4-digit size code. You must refer to the actual manufacturer's data sheet to get information regarding thickness.

Below are the most common size codes for capacitors and resistors:

<u>Size Code</u>		<u>Approximate Size (LxW)</u>	
<u>Inch</u>	<u>Metric</u>	<u>Inch</u>	<u>Metric</u>
0402	1005*	.04" x .02"	1.0 x 0.5mm
0504	1210*	.05" x .04"	1.2 x 1.0mm
0603	1508	.06" x .03"	1.5 x 0.8mm
0805	2012	.08" x .05"	2.0 x 1.2mm
1005*	2512	.10" x .05"	2.5 x 1.2mm
1206	3216	.12" x .06"	3.2 x 1.6mm
1210*	3225	.12" x .10"	3.2 x 2.5mm
1812	4532	.18" x .12"	4.5 x 3.2mm
2225	5664	.22" x .25"	5.6 x 6.4mm

* *Caution: Overlapping size codes. Metric appears same as inches.*

FLAT CHIPS

- **Capacitors & Resistors**
- **Dimensions**
 - USA = Inches
 - Outside USA = Metric or Inches

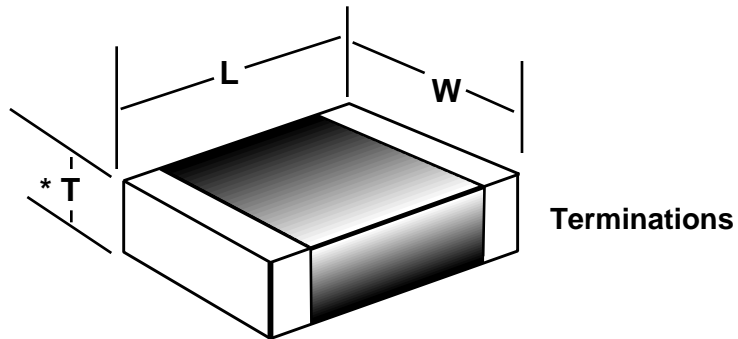

*Thickness is not included
in the 4-digit size code.

Example:

Caution: Must verify if size
code is metric or
inches.

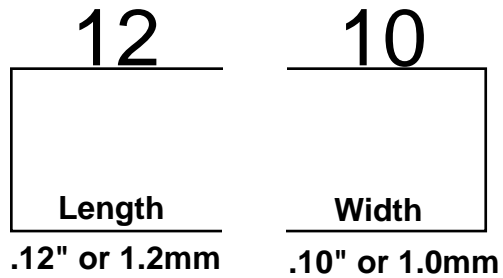

FLAT CHIP TRENDS

At the present time, component handling equipment capable of handling 0402 size components is not widely available. However, new equipment capable of handling small sized components is rapidly being developed.

Small sized components are also more difficult to solder and service in the field.

In fact, the 0402 is so small, it looks just like a grain of black pepper found in your kitchen.

Japan is leading the way towards miniaturization. It is still common for American firms to use 1206 and 0805 resistors, while most Japanese companies use only 0805 and 0603 sizes. Americans are slowly incorporating 0603 resistors and capacitors into their new designs.

0402 is in the prototype stage in Japan, the USA and Europe.

FLAT CHIPS

TRENDS

- Chips Are Getting Smaller
- Japan Leading the Way Toward Miniaturization
- Component Handling Infrastructure Not Yet Widely Available for 0402 Size

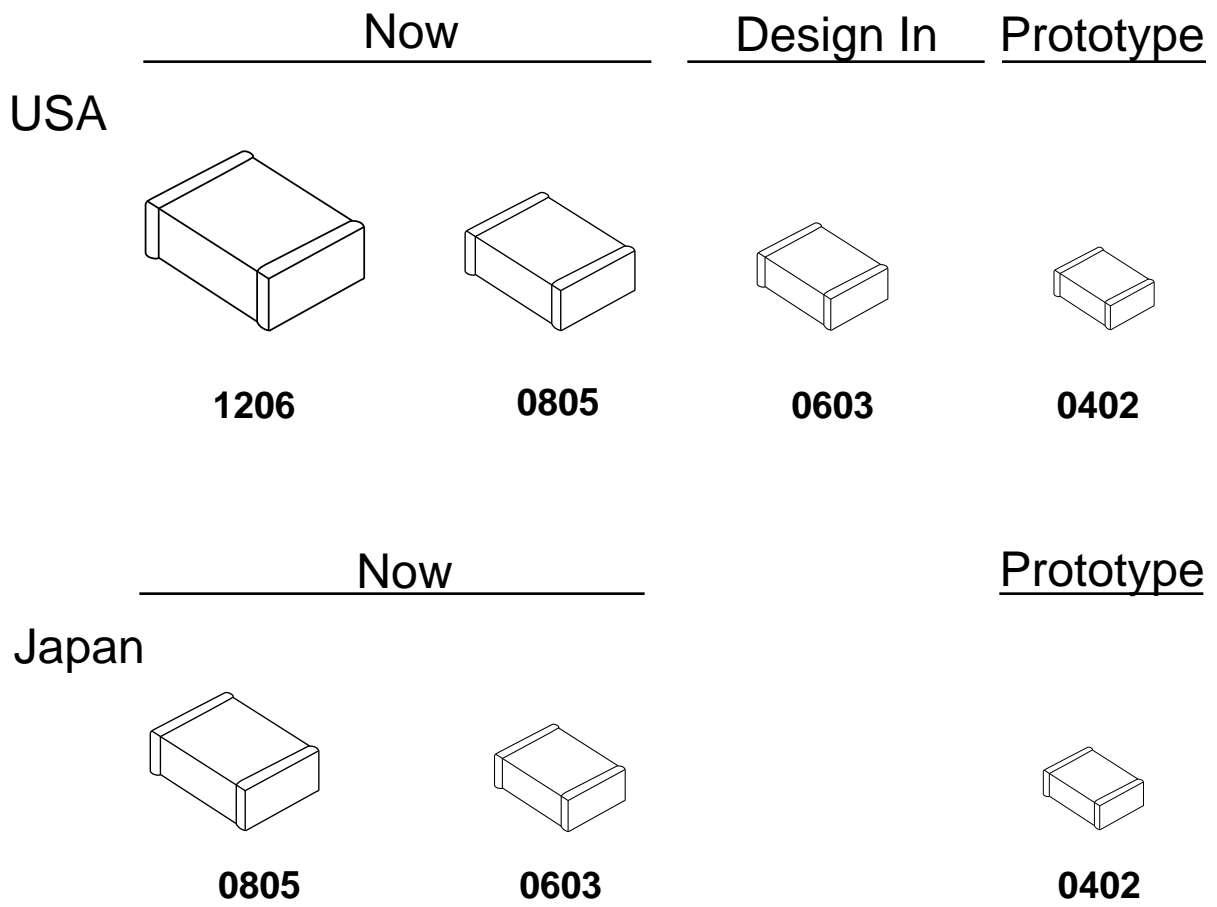

FLAT CHIP PACKAGING

7 inch (178mm) diameter reels are standard around the world for capacitors and resistors. These reels can hold 5,000 resistors and typically 3,000 to 4,000 capacitors.

13 inch (330mm) reels are available on special order for higher volume users. The large reel holds more components (example: 10,000 parts) and requires less handling than do 7 inch (178mm) reels.

Paper (cardboard) reels with punched paper carrier tape are the most popular packaging for resistors.

Plastic reels with embossed plastic carrier tape are the most popular packaging choice for ceramic multilayer capacitors.

Nevertheless, capacitors are available with paper tape and paper reels, and resistors are available with plastic tape and plastic reels.

For low volume assembly, bulk packaging in plastic (vinyl) bags is acceptable.

An alternative type of packaging is now being offered by Japanese firms. Refillable chip shooters (plastic dispensing boxes) and cassette holders offer several environmental advantages over tape and reel packaging.

Chip shooters consume less physical space and weigh less than tape and reel. Therefore, freight charges (and gas/petrol consumption) are lower.

Since paper tape and paper reels waste trees, refillable chip shooters conserve our forests and natural resources.

Finally, plastic tape and plastic reels are not biodegradable and this raises further concern over environmental issues.

FLAT CHIP PACKAGING Tape & Reel

REEL MATERIAL

- PLASTIC
- PAPER

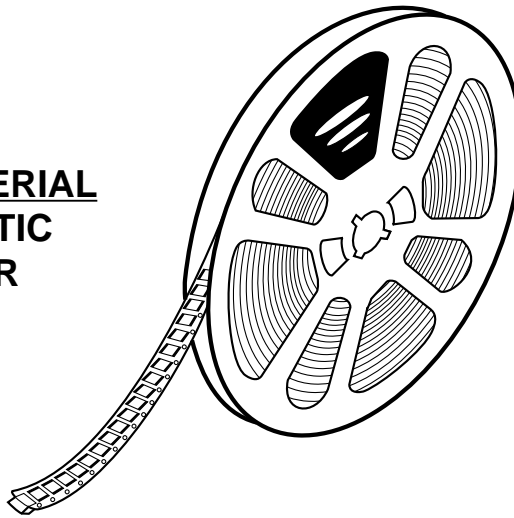

**7" DIAMETER
STANDARD**

**13" SPECIAL
ORDER**

CARRIER TAPE

Capacitors

1st Choice Plastic
2nd Choice Paper

Resistors

1st Choice Paper
2nd Choice Plastic

MELF COMPONENTS

MELF components are more popular in Japan and Europe than in the USA.

MELF stands for Metal Electrode Face Bonded and consists of two terminals bonded into a cylindrical body.

MELF resistors and capacitors are less expensive than their flat chip counterparts; however, they require special handling during assembly.

The biggest disadvantage of MELF components is that they may tend to roll off their solder pads during assembly.

Diodes are also available in MELF and mini-melf packages.

CYLINDRICAL MELF COMPONENTS

- **Diodes**
- **Resistors**
- **Capacitors**
- **MELF Not Popular in USA**
- **Rolls on PC Board**

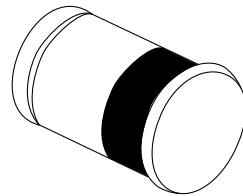

Capacitors

Resistors

- **0805**
- **1206**
- **1406**
- **2308**

Diodes

- **SOD 80 Mini-melf**
1.6mm x 3.5 mm
- **SM1 Melf**
2.5mm x 5.0mm

MOLDED TANTALUM CAPACITORS

Several years ago, the electronic industry adopted the E.I.A. (American) and I.E.C.Q. (European) standard case sizes for molded tantalum capacitors.

The Japanese EIAJ standard is not fully compatible with American and European standards.

The E.I.A. and I.E.C.Q. have established four standard case sizes. These case sizes are designated with the letters A, B, C, D or by their 4-digit metric size code. Package height is not included in the size code.

<u>EIA/IECQ Size Code</u>	<u>Metric Code</u>	<u>Metric Footprint</u>
A	3216	3.2 X 1.6mm
B	3528	3.5 x 2.8mm
C	6032	6.0 x 3.2mm
D	7343	7.3 x 4.3mm

The most common packaging for molded tantalum capacitors is plastic tape and either plastic or cardboard reels.

MOLDED TANTALUM CAPACITORS

E.I.A. Sizes
A, B, C, D

Footprint is Metric

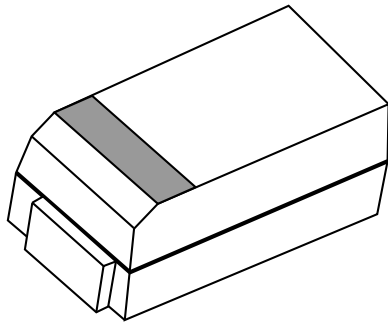

Example:

A case =



TRANSISTORS AND DIODES

Rectangular transistors and diodes are SOT packages (Small Outline Transistor).

The most popular size is the SOT23. Other packages include the SOT89, SOT143 and SOT223.

The Japanese have designated the SC59 which is almost the same size as the SOT23.

In addition, the Japanese have developed the Mini-SOT which is approximately one-half the size of a standard SOT23.

Motorola developed the DPAK and D2 PAK to house higher-powered devices. The D2 PAK was designed to replace the popular TO220 leaded transistor.

TRENDS

Packages for rectangular diodes and transistors are getting both smaller and bigger.

The smallest rectangular transistor is now the mini-SOT, and it is gaining popularity in Japan.

The biggest surface mount transistor is the D2 PAK which was developed by Motorola to offer a direct footprint equivalent to the popular through-hole TO220 package.

Larger packages are designed to accommodate high power silicon die.

SOT TRANSISTORS And DIODES

SOT FEATURES

- Rectangular
- Easy Placement
- Old Technology
- SOT 23, SOT 89
SOT 143, SOT 223

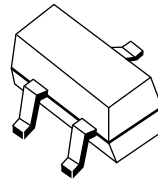

SOT 23
Most Popular

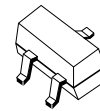

Mini SOT

DPAK FEATURES

- Replaces TO220
- High Power
- Tape & Reel

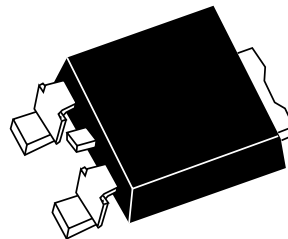

DPAK

TRANSISTOR AND DIODE PACKAGING

Tape and reel is the most popular packaging for SMD transistors and diodes. Smaller SOT packages are mounted on 7 inch (178mm) reels. Larger packages such as DPAK and D2 PAK are normally sold on 13 inch (330mm) reels.

Typical Quantity on Reel

Package	Qty
SOT23	3,000
SOT 89	1,000
SOT 143	2,000
SOT 223	1,000
DPAK	2,500
SOD80	2,500
SM1 MELF	1,500

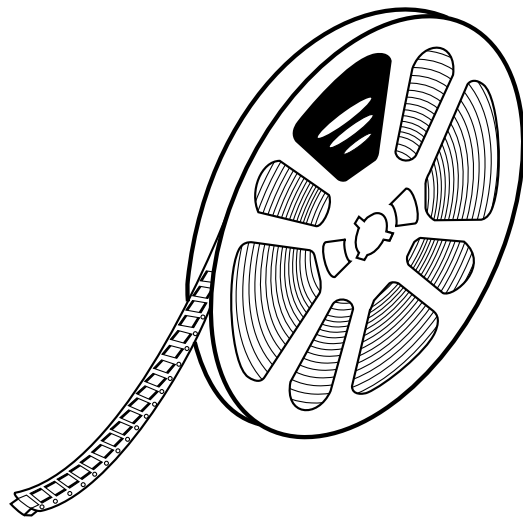

**Always plastic
carrier tape**

Orientation

Caution must be taken in ordering SOT23 with the correct orientation. There are two choices: T1 and T2. The T1 orientation is the most popular and has one lead of the SOT23 facing the sprocket holes on the carrier tape. The T2 is oriented on the tape with two leads facing the sprocket holes.

TRANSISTOR & DIODE PACKAGING

- **Most Popular T&R**
- **SOT = 7" Reel**
- **DPAK = 13" Reel**

CARRIER TAPE

- **Always Plastic**

ORIENTATION

- **T1 SOT23 1 Lead Toward Spocket Holes
(Most Preferred)**
- **T2 SOT23 2 Leads Toward Spocket Holes**

SMD INTEGRATED CIRCUITS FAMILY

Package types for surface mount integrated circuits can be grouped into families.

The flat pack is old technology.

The QUAD flat pack and TSOP use newer technology.

Each family has certain characteristics in common such as lead style, lead pitch, body size and case materials.

The remainder of this book is devoted to describing SMD integrated circuits.

SMD IC FAMILY OVERVIEW

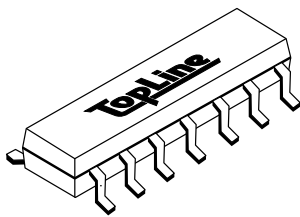

**SMALL
OUTLINE**

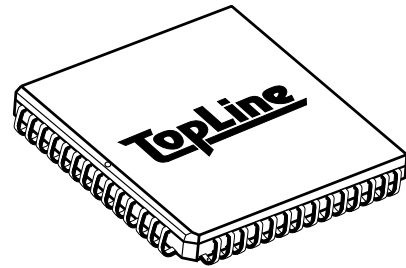

**LEADED CHIP
CARRIER**

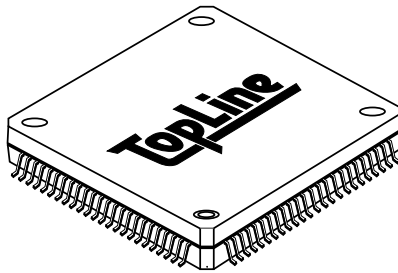

QUAD FLAT PACK

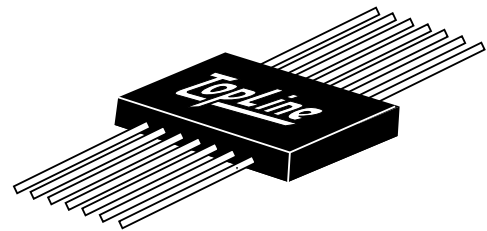

FLAT PACK

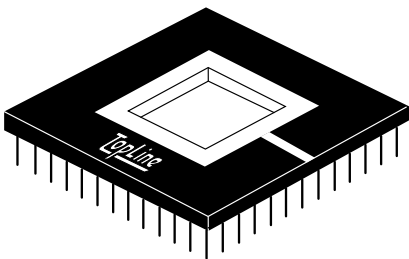

PIN GRID ARRAY

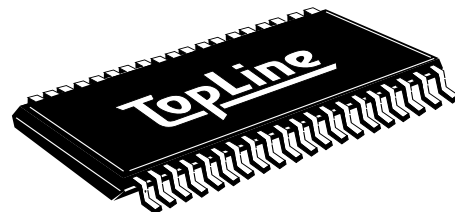

TSOP

LEAD STYLES

Let's start by learning the three basic lead styles. Each lead has a name which resembles its shape.

Gull-wing leads are small and quite fragile. They can easily be damaged and must be handled with great care.

Gull-wing leads are used to get the highest number of leads onto an IC. It is possible to get 40 to 80 leads per linear inch (15 to 33 leads per cm) onto an IC using gull-wing leads. Gull-wing leads are easy to inspect after soldering.

J-leads are more sturdy than gull-wing leads; however, they take up more space. With J-leads, you can only get 20 leads per linear inch (8 leads per cm) on an IC package.

Flat leads are also used on IC's. Flat leads must be stored in special carriers to prevent lead damage.

Just prior to use, IC's with flat leads are cut and bent into gull-wings by using lead forming equipment. Lead forming equipment is an extra expense. Therefore, flat leads are the least popular type of IC lead.

The words lead pitch are synonymous with lead space.

SMD LEADS STYLES

• GULL-WING

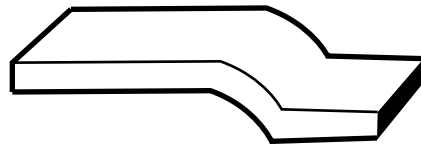

• J-LEAD

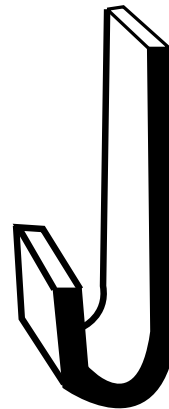

• FLAT



SOIC SMALL OUTLINE NOMENCLATURE

Small Outline IC's belong to a family of packages with a variety of lead styles and lead counts. Small outline packages are called by over 10 different names. There are small differences between each type, and often they are called by the wrong name. On pages 22 - 23, we will discuss the differences.

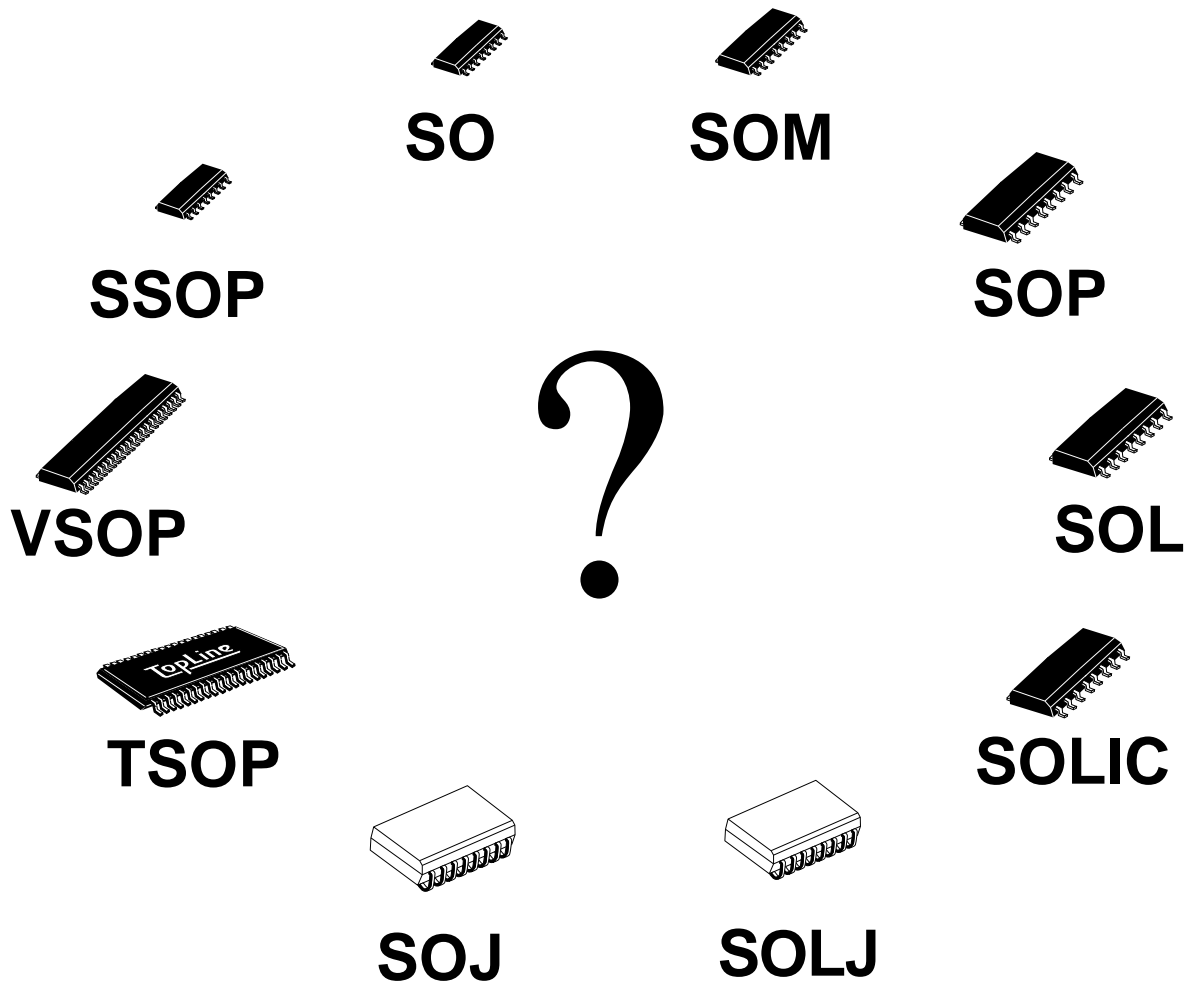

SOIC TRENDS

The trend toward higher density (more leads) continues.

The new VSOP, QSOP and SSOP doubles the number of leads while maintaining the traditional small outline appearance. This is accomplished by decreasing the lead pitch from 50 mils (1.27mm) down to 25 mils (.636 mm).

Also, there is a trend to package larger silicon die into wider body SOIC's. This is accomplished by expanding the package width from 300 mils (7.63mm) to 330 mils (8.4mm), 350 mils (8.9mm), 400 mils (10mm) and even 440 mils (11.1mm).

The TSOP package combines a low profile case with high density lead pitch of 19.7 mils (.5mm). The future looks bright for TSOP packages.

The traditional 150 mil (3.97mm) SO package and 300 mil (7.63mm) SOL package are now commonplace in the industry.

SMALL OUTLINE INTEGRATED CIRCUIT (SOIC)

SO Small Outline is the original design. It consists of a molded plastic case measuring approximately 156 mils (3.97mm) wide, and has gull-wing leads with 50 mils (1.27mm) lead pitch.

SOM - Small Outline Medium measures 220 mils (5.6mm) wide. SOM packages are normally used for resistor networks.

SOL - Small Outline Large measures 300 mils (7.62mm) wide. Wider packages measuring 330 mils, 350 mils, 400 mils and 450 mils are also lumped into the **SOL** family.

SOP - Small Outline Package is a Japanese term which is used the same way as **SO** and **SOL**.

SOJ and SOLJ - Small Outline J-Lead is used to describe SOL packages with J-leads.

VSOP - Very Small Outline Package refers to packages with high density 25 mil (.65mm) gull-wing leads. Sometimes the term VSOP and SSOP (see below) are interchangeable. 300 mil (7.62mm) wide body.

SSOP - Shrink Small Outline Package is the same as VSOP; however, it has a smaller 208 mil (5.3mm) case.

QSOP-Quarter Small Outline Package are the same as the original SO package with 25 mil pitch.

Note: *The length of the body is determined by the number of leads.*

SOIC SMALL OUTLINE Integrated Circuit

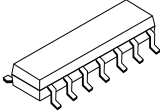
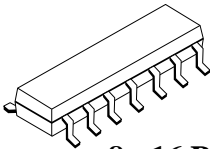
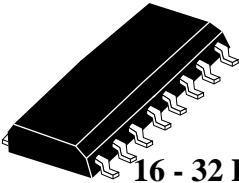
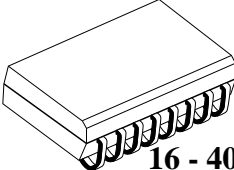
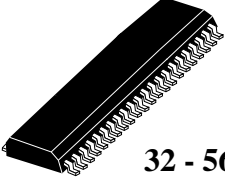
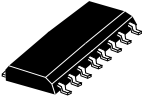
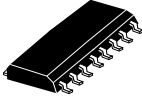
DRAWING	NOMENCLATURE	BODY WIDTH	LEAD TYPE
 8 - 16 PIN	SO = Small Outline	156 mil	Gull 50 mil Pitch
 8 - 16 PIN	SOM = Medium Outline	220 mil*	
 16 - 32 PIN	SOL = "Large" Outline SOP = "Small" Outline Package	300 mil	
 16 - 40 PIN	SOJ or SOL-J = "J" - Lead Large Outline	300 mil*	J- Lead 50 mil
 32 - 56 PIN	VSOP = Very Small Outline Package	300 mil	Gull Wing 25 mil
 8 - 30 PIN	SSOP = Shrink Small Outline Package	208 mil	Gull Wing 25 mil
 20 - 56 PIN	QSOP = Quarter Small Outline Package	156 mil	Gull Wing 25 mil

*Up to 440 mils

SOIC PACKAGING

13 inch (330mm) reels are standard for SOIC's. The carrier tape is always plastic and measures 12mm to 32mm in width depending on the IC package size.

EXAMPLE OF T&R SOIC PACKAGING

Gull Wing Lead			J-Lead		
Part	Qty on Reel	Tape Width	Part	Qty on Reel	Tape Width
S08	2,500	12mm	SOLJ16	1,000	16mm
SO14	2,500	16mm	SOLJ18	1,000	24mm
SOM14	2,000	16mm	SOLJ20	1,000	24mm
SO16	2,500	16mm	*SOLJ20/24	1,000	24mm
SOM16	2,000	16mm	SOLJ24	1,000	24mm
SOL16	1,000	16mm	SOLJ28	1,000	24mm
SOL18	1,000	24mm	SOWJ28	500	24mm
SOL20	1,000	24mm			
SOL24	1,000	24mm			
SOW32	1,000	32mm			

SOW = 330 mil wide

*20 pin DRAM in 24 lead package

SOIC's are also readily available in plastic tubes. These tubes are sometimes called magazines or sticks.

**TAPE
& REEL**
13" STANDARD

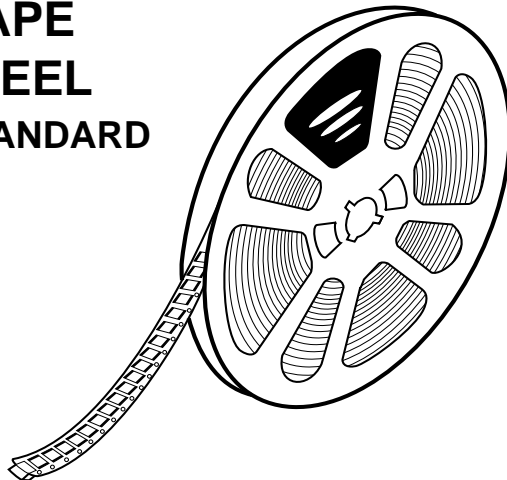

TUBE

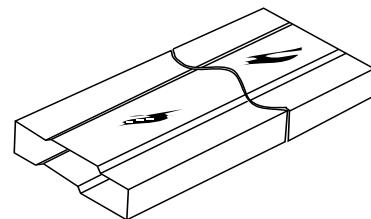

TSOP THIN SMALL OUTLINE PACKAGE

The TSOP (Thin small outline package) combines a low profile package (1.0mm high) with fine-pitch 19.7 mils (.5mm) leads.

The TSOP provides a package which accommodates a large silicon chip in a high density package.

TSOP's are usually shipped in trays; however, tape and reel and tubes are available on special request.

The overall dimensions of TSOP's include the leads (total footprint).

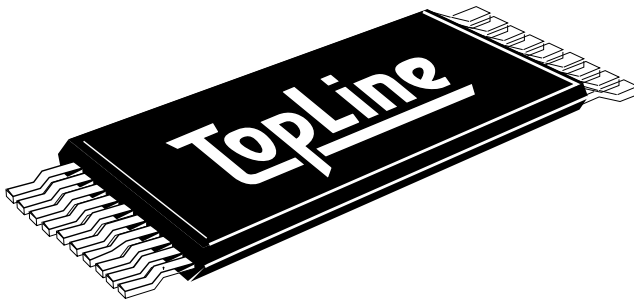

TYPE T1
20 to 56 Lead
0.5mm pitch

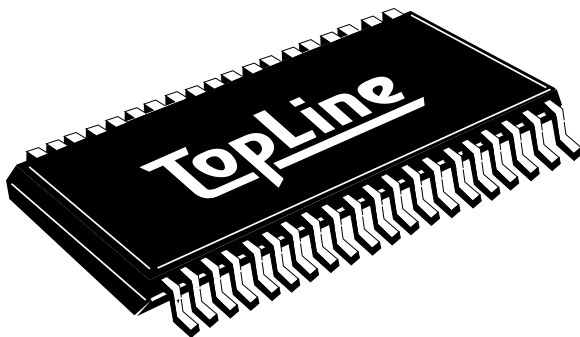

TYPE T2
20 Leads
1.27mm pitch

PLCC LEADED CHIP CARRIER

The plastic body PLCC is the most popular leaded chip carrier. Its J-leads are always 50 mil (1.27mm) pitch. They are commonly available from 18 to 100 leads. PLCC's are usually supplied in tubes or on tape and reel.

As an alternative to the plastic case, leaded chip carriers are available in ceramic, known as CLCC, and metal, known as MLCC.

PLCC's fit into IC sockets and can be easily replaced in the field.

PLCC's have been in use for over a decade and are now a common item.

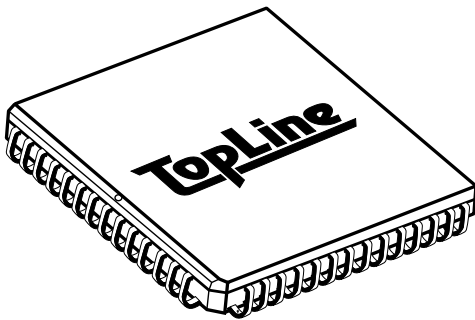

- **PLCC - Plastic Leaded Chip Carrier**
- **J-Lead Only**
- **18 to 100 Leads**
- **50 mil Pitch**
- **Available in Ceramic Body - CLCC**
- **Available in Metal Body - MLCC**
- **Fits Into IC Sockets**
- **T&R or Tubes**
- **Trends - PLCC is Common Item
No New Development**

LCC LEADLESS CHIP CARRIER

The ceramic LCC is one of the most rugged packages since it has no leads to damage. LCC's are soldered directly to PC boards by their solder pads, known as castellations. Most LCC's come with 50 mil pitch gold castellations which must be pre-coated with solder before mounting.

LCC's are usually designed for Mil Spec, aerospace and high temperature applications.

LCC's are shipped in either trays or tubes.

Sometimes LCC's are called LCCC (Leadless Ceramic Chip Carrier).

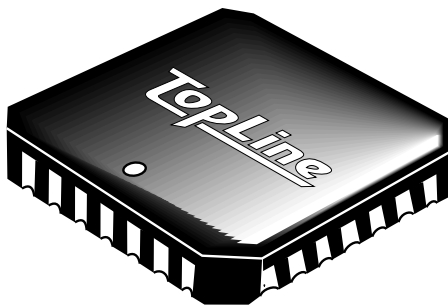

- **LCC**
- **Solderable Castellation Pads**
- **16 Pin to 44 Pin (up to 124 pin)**
- **Rugged, No Leads to Bend**
- **Ceramic Body**
- **High Temp & MilSpec Applications**
- **Usually Tubes or Trays**

FLAT PACKS

The flat pack is the oldest surface mount IC package.

Since flat packs only are available with 50 mil (1.27mm) lead pitch, they have a low lead count such as 14, 16 or 28 leads, though some large flat packs have up to 80 leads.

Flat packs are used only for Mil Spec, aerospace and other limited applications.

Their flat leads must be kept straight in plastic carriers and require lead forming just prior to use. Flat packs usually have gold leads which must be pre-tinned prior to assembly.

It should be noted that flat packs have leads extending from only two sides of their body. (See quad flat pack for leads extending from four sides.)

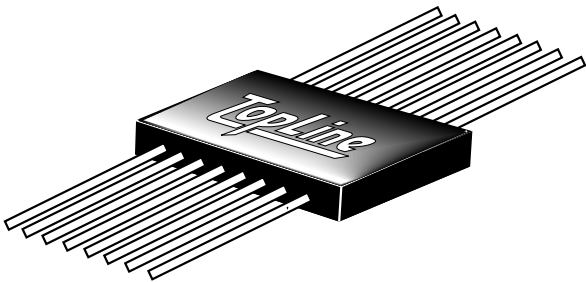

- **Usually Flat Leads**
- **50 mil Pitch**
- **Must be Formed Prior to Use**
- **Mil-Spec Applications**
- **10 pin to 28 (up to 80)**
- **Older Technology**
- **No Significant Trends**
- **Limited Applications**

QFP QUAD FLAT PACK

Quad flat packs are high lead count packages.

Quad flat packs are known as fine-pitch devices, since their lead pitch is often 25.6 mils (.65mm) down to 11.8 mils (.3mm).

The quad flat pack family is available with many options and are called by many names. See next page for list.

There is still development work going on with quad flat packs.

Lead counts as high as 304 leads are available.

Non-bumpered QFP's are built to Japan's EIAJ metric standard; whereas, bumpered (BQFP's - see page 32) are built to American JEDEC standards.

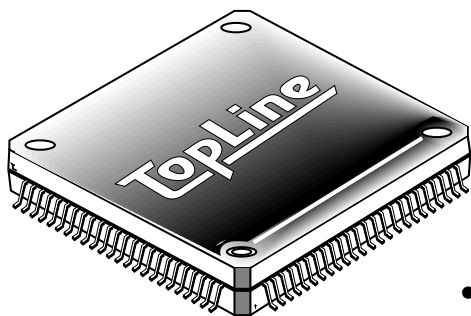

- **EIAJ Standards (Japan)**
- **No Bumpers**
- **Gull-Wing**
- **44 to 304 leads Now in Production**
- **.8mm to .3mm Pitch**
- **Usually Packaged in Trays**
- **T&R Special Order**

QUAD FLAT PACK NOMENCLATURE

There are many variations of quad flat packs depending on package materials (plastic, ceramic or metal) and other standards.

Nomenclature

- **QFP** - **Quad Flat Pack**
- **PQFP** - **Plastic Quad Flat Pack**
- **CQFP** - **Ceramic Multilayer QFP**
- **CERQUAD** - **Ceramic Quad Flat Pack**
- **MQUAD[®]** - **Metal Quad Flat Pack**
- **MQFP** - **Metric Quad Flat Pack**
- **TQFP** - **Thin Quad Flat Pack**
- **TAPEPAK[®]** - **Molded Carrier Ring**
- **BQFP** - **Bumpered Quad Flat Pack**
- **LQFP** - **Low Quad Flat Pack**

[®]MQUAD is a registered trademark of Indy Corporation

[®]TapePak is a registered trademark of National Semiconductor Corporation

NOMENCLATURE QUAD FLAT PACKS

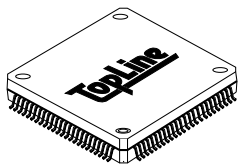

QFP

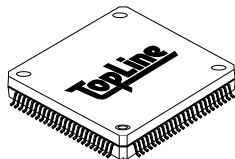

PQFP

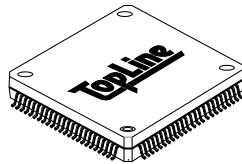

MQFP

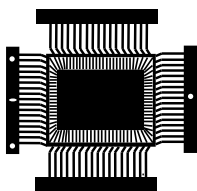

CQFP

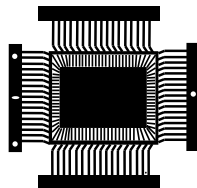

CERQUAD

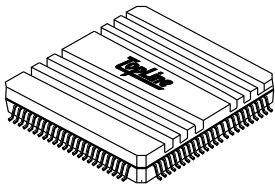

MQQUAD®

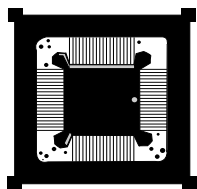

TAPEPAK®

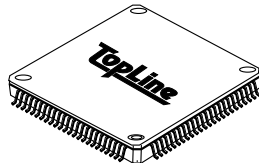

TQFP

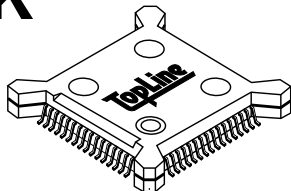

BQFP

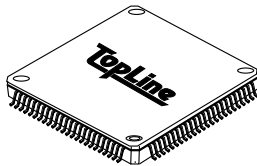

LQFP

BQFP BUMPERED QUAD FLAT PACK

The bumpered quad flat pack is built to American JEDEC standards using true inch measurements. This means that 25 mil lead pitch is truly 25 mils (.636mm not .65mm).

The purpose of the bumpered corners is to protect the leads during shipping, handling and assembly.

BQFP's are constructed in a plastic package; however, they are also available with metal case, known as the BMQUAD.

BQFP's always have gull-wing leads and are shipped in trays, tubes or on tape and reel.

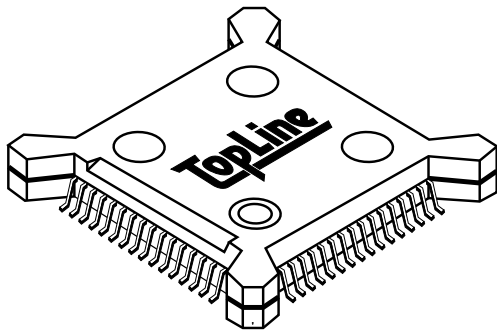

- **JEDEC Standard (USA)**
- **Bumpered Corners - Protects Leads**
- **Gull-Wing**
- **Up to 196 Leads**
- **Package Options - Trays, Tubes and T&R**
- **True 25 mil (.636mm) Pitch**

TAPEPAK® Molded Carrier Ring

TapePak® was invented by National Semiconductor and is now licensed for production by several manufacturers.

Known for its molded carrier ring, the leads remain safe from damage. The molded carrier ring allows the device to be tested before the need to cut and form the leads.

Leads up to 304 are now available with TapePak.®

The main disadvantage with TapePak® is the added expense to provide lead forming equipment.

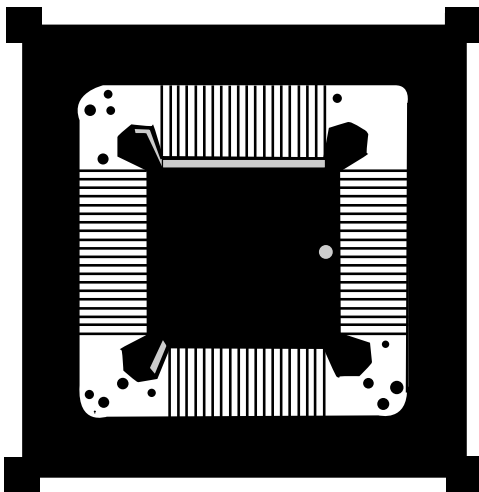

- **Molded Carrier Ring
Keeps Leads Flat Prior to Use**
- **Allows Automated Testing**
- **120 pins to 304 pins**
- **25mil to 15.7mil Pitch**
- **0.65mm to 0.4mm Pitch**
- **Coin Stack in Tubes**
- **Requires Lead Forming
Equipment**

FLIP CHIPS

Flip chips are bare die with small solder bumps on the bottom which serve as "leads."

The flip chip is soldered directly to a PC Board (FR4 or ceramic) by placing the component on the board and applying heat. The solder bumps melt to corresponding pads on the PC Board.

The following solder type (Eutectic) is used for the bumps:

FR4 Boards 63% - 37% low melt (183°C)

Ceramic Boards: 95% - 5% requires high temp

Bump on the die are around the perimeter and also in the middle.

Since the parts are small, dimensions are specified in "microns" not millimeters.

100µm = 1 millimeter

Important Package Specifiers:

- A. Die Size
- B. Number Bumps
- C. Diameter of Bumps
- D. Solder Composition of Bumps
- E. Bump Pitch

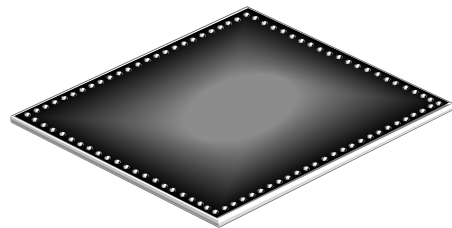

FINE PITCH TERMINOLOGY

- **Coplanarity - 4 mil max (.1mm)**
A setting plane is formed by the first 3 leads touching the surface. All other leads are measured from this plane.
- **Sweep - Sideways Bending of Gull-Wing Leads**
- **Tweeze -The Inward Bending of Gull-Wing Leads**
- **Caution! Use Metric Footprints**

.65mm \neq 25 mil (25.6 mil)

.5mm \neq 20 mil (19.7 mil)

.4mm \neq 15 mil (15.7 mil)

.3mm \neq 12 mil (1.8 mil)

Solder Practice Kits



TopLine, with their Solder Practice Kits, makes practicing with the latest technological advancements accessible and affordable. These three popular kits are designed from beginners to advanced practice. The BGA kit supports BGAs, with grid pattern, and daisy chain test points to verify placement. The Challenger Kit includes a wide selection of SMD components, including fine pitch QFP, PLCC, SOIC, PLCC and discrete components. The Advanced Rework Kit was designed especially for hand-solder or machine run. Solder paste artwork, parts placement data and solder paste stencils are also available.

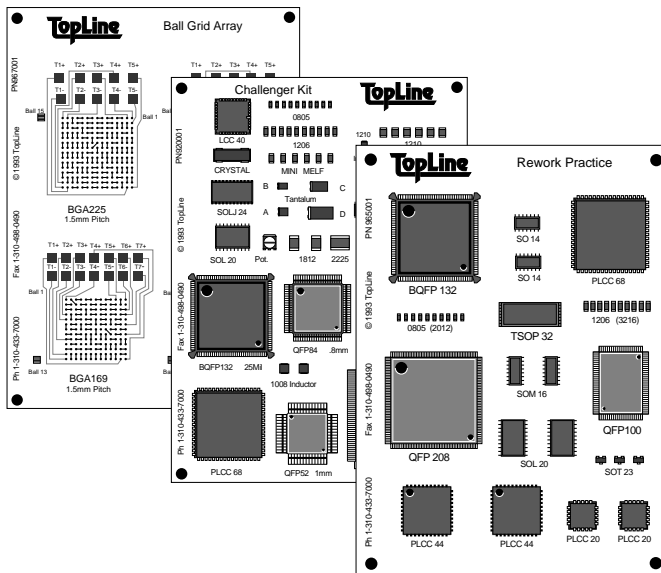

TopLine™ is the world's leading supplier of Dummy Components.

With a vast network of distributors spanning 40 countries worldwide, TopLine supports pick and place manufacturers, educational institutions, as well as many other rapidly expanding markets. Customer service is of the utmost importance at TopLine. That's why we guarantee the quality of our products. Call today to receive your free TopLine catalog.

TopLine™

95 Highway 22 W

Milledgeville, GA

31061, USA

info@TopLine.tv

www.TopLine.tv

Tel : 1-478-451-5000

Fax : 1-478-451-3000

